

Tebis application software

- Manufacturers
- Hager Electro
- Meter
- Energy meter

STE331 - Consumption indicator

Electrical / Mechanical characteristics: see product information

	Product reference	Product designation
	TE331	Consumption indicator

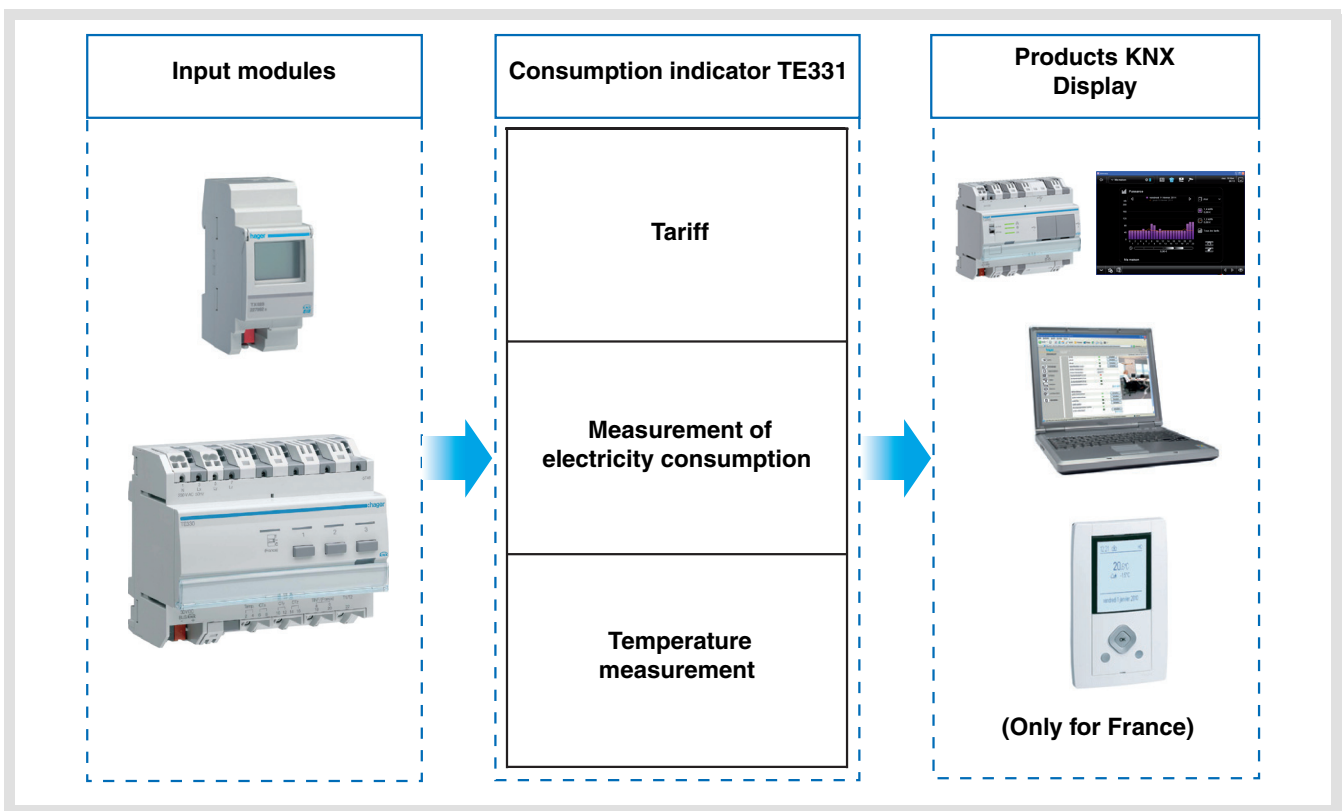

Summary

1. Description of the system.....	3
1.1 General overview.....	3
1.2 General outline	4
2. Presentation of the functions	5
2.1 Main functions overview	5
2.2 Description of measurement.....	6
2.3 Possible installations	10
2.4 "Tele-information" tariff.....	11
2.5 Description of temperature measurement	12
2.6 Tariff management for the product: with or without tariff	12
2.7 Contract power exceeded.....	13
3. Configuration and settings	14
3.1 Objects List.....	14
3.2 General parameters.....	19
3.3 Metering input.....	22
3.3.1 Télé-info metering input	22
3.3.2 Input 1 to 3 metering	24
3.3.3 Addition metering	26
3.3.4 Other metering	27
3.3.5 Three-phase metering	28
4. Configuration and use with domovea.....	29
4.1 Adding the device	29
4.2 Choice of tariff under domovea	30
5. Technical characteristics.....	32
5.1 Installation	32
5.2 Meaning of the LED's	32
5.3 Current outage and return	34
5.4 Connection of the toroids according to the number of phases	34
6. Main characteristics	36
7. Physical addressing	36

1. Description of the system

1.1 General overview

The consumption indicator informs users of their consumption through several metering channels including one specifically dedicated to "Tele-information"*. It is used to monitor and control energy consumption and is built into an automatic global energy management system.

The available metering channels are:

- Télé-info metering input,
- Metering input 1,
- Metering input 2,
- Metering input 3,
- Addition metering,
- Three-phase load metering,
- Other metering.

It is also used to measure the energy produced for installations with a photovoltaic system.

This product can be used in a single-phase or three-phase installation.

All this data is sent on the KNX bus.

In addition to metering, the consumption indicator also has:

- 2 tariff inputs: "Tele-information" and "T1 / T2",
- a temperature input for the connection of a probe.

The system can be constructed with several TE331 on the bus. This thus makes it possible to measure one or more circuits using toroids.

The consumption indicator is adapted to display consumption. It can also be interfaced with the ambiance units or other display systems thanks to object sent on the KNX bus.

It is used to display the current tariff and the energy consumption according to the current tariff. The tariff can also be distributed to other devices on the bus.

* Only used in France - See chapter 2.4.

1.2 General outline

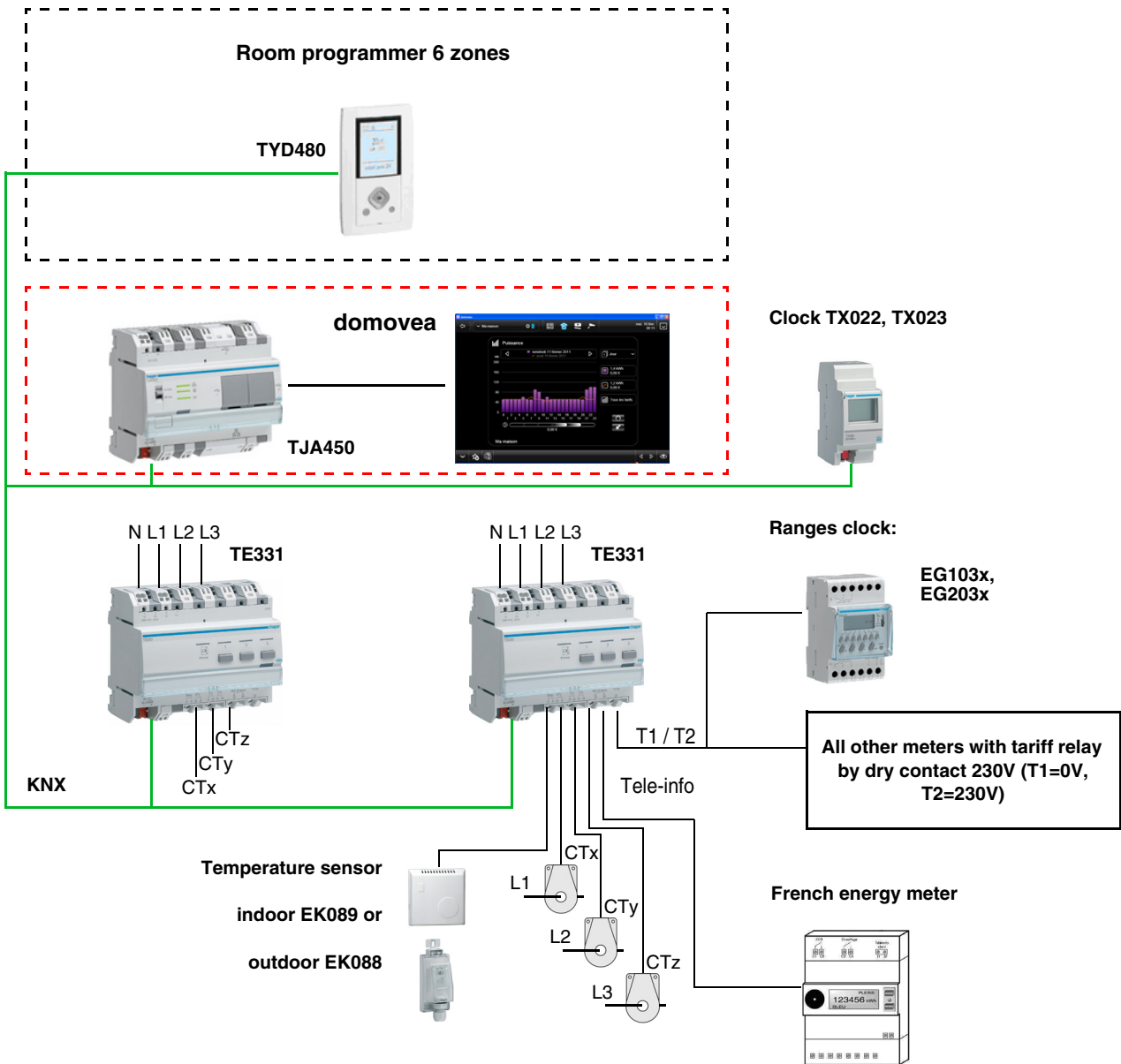

2. Presentation of the functions

2.1 Main functions overview

■ Tariff

The function is used to:

- Supply the value of the current tariff on the bus for an ambiance display,
- Supply the value of the tariff to come on the bus for an ambiance display - only available with Tele-information in France,
- Index the current tariff to each metering measurement.

■ Power

The function is used to supply the power demand value on the bus for each metering channel.

■ Energy

The function is used to supply the consumed energy value on the bus for each metering input. It is available in 4 byte or 6 byte format.

■ Voltage

The function is used to supply the voltage demand value for each metering input.

■ Strength

The function is used to supply the current demand value for each metering input.

■ Partial meter Reset

The function is used to reset the partial counters to zero for all the metering inputs.

■ Metering data dynamic mode

The function is used to refresh the metering data at a higher frequency.

The control is received from a display interface when the request for data display is made.

■ Contract power exceeded

The function is used to detect when the electrical power contracted from the energy supplier is exceeded. Connection to the télé-info link of the subscriber's meter is mandatory for this function.

■ Temperature measurement

The function is used to measure the temperature via a temperature probe.

The data is sent on the bus for remote display.

2.2 Description of measurement

The consumption indicator has 7 measurement channels:

- 3 physical channels used to measure voltage and current,
- 1 virtual channel **tele-information** used to measure the total consumption,
- 1 virtual channel **addition** used to add up the physical channels,
- 1 virtual channel **others** used to calculate the difference between the **tele-information** channel and the physical channels,
- 1 virtual channel **three-phase** uniting the 3 physical channels to create a single channel.

- 3 measurement channels per toroid

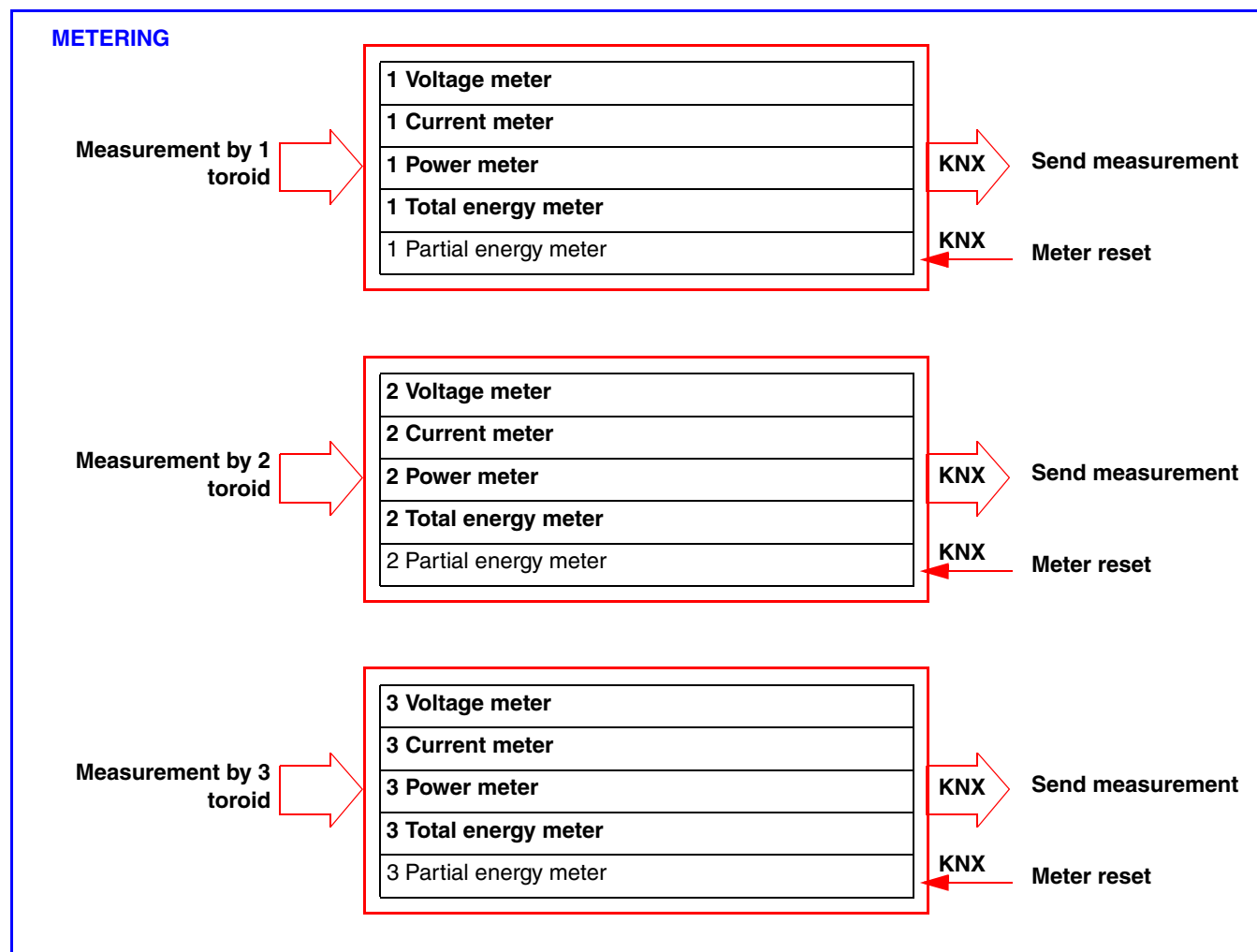

The current is measured using toroids. The polarity of the toroids is of no importance.

- 1 channel to report the data from the general meter by tele-information (Only for France).

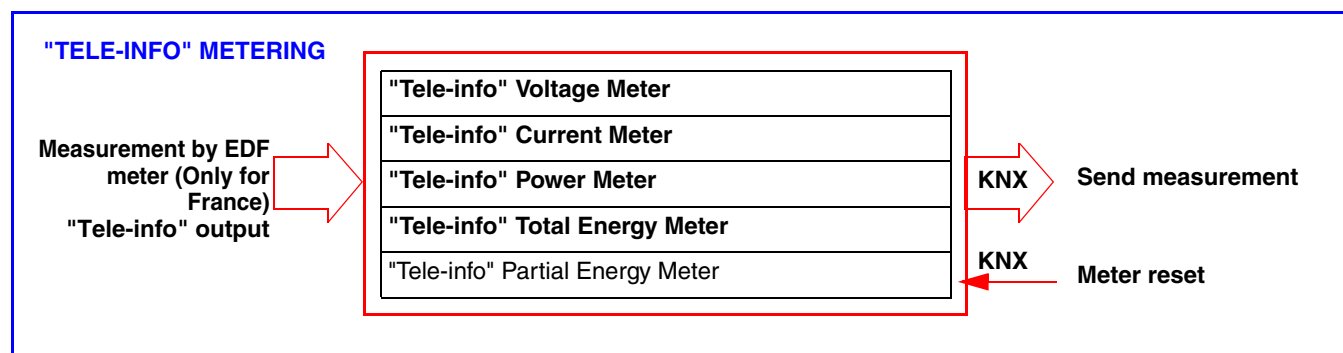

- 1 measurement channel by addition of the channels

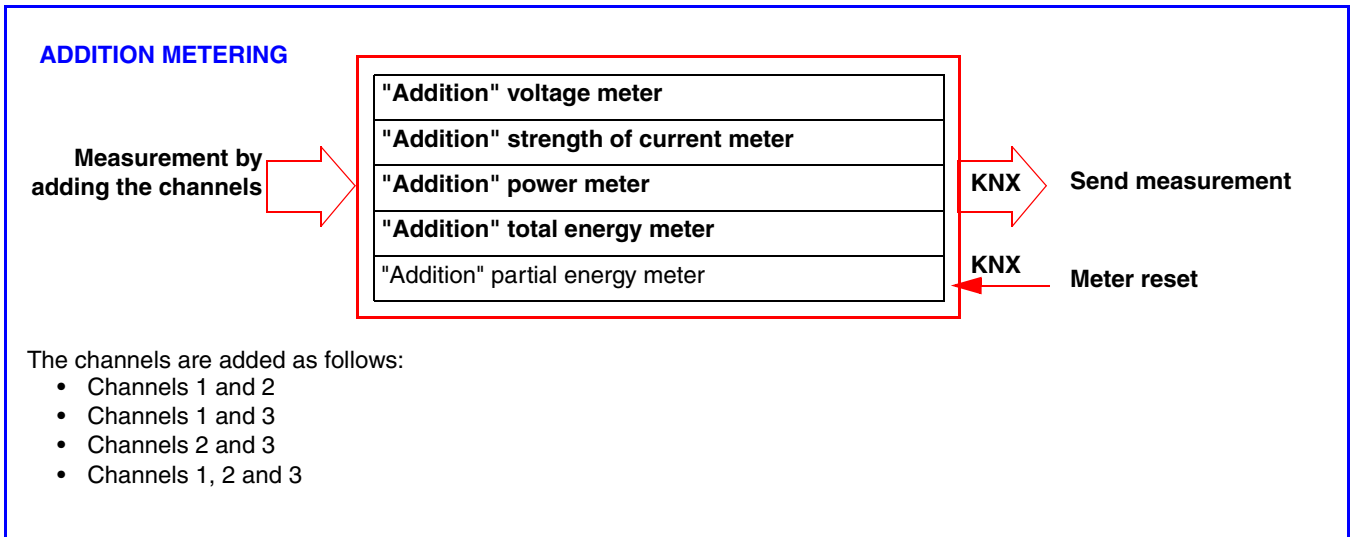

- 1 measurement channel by calculation

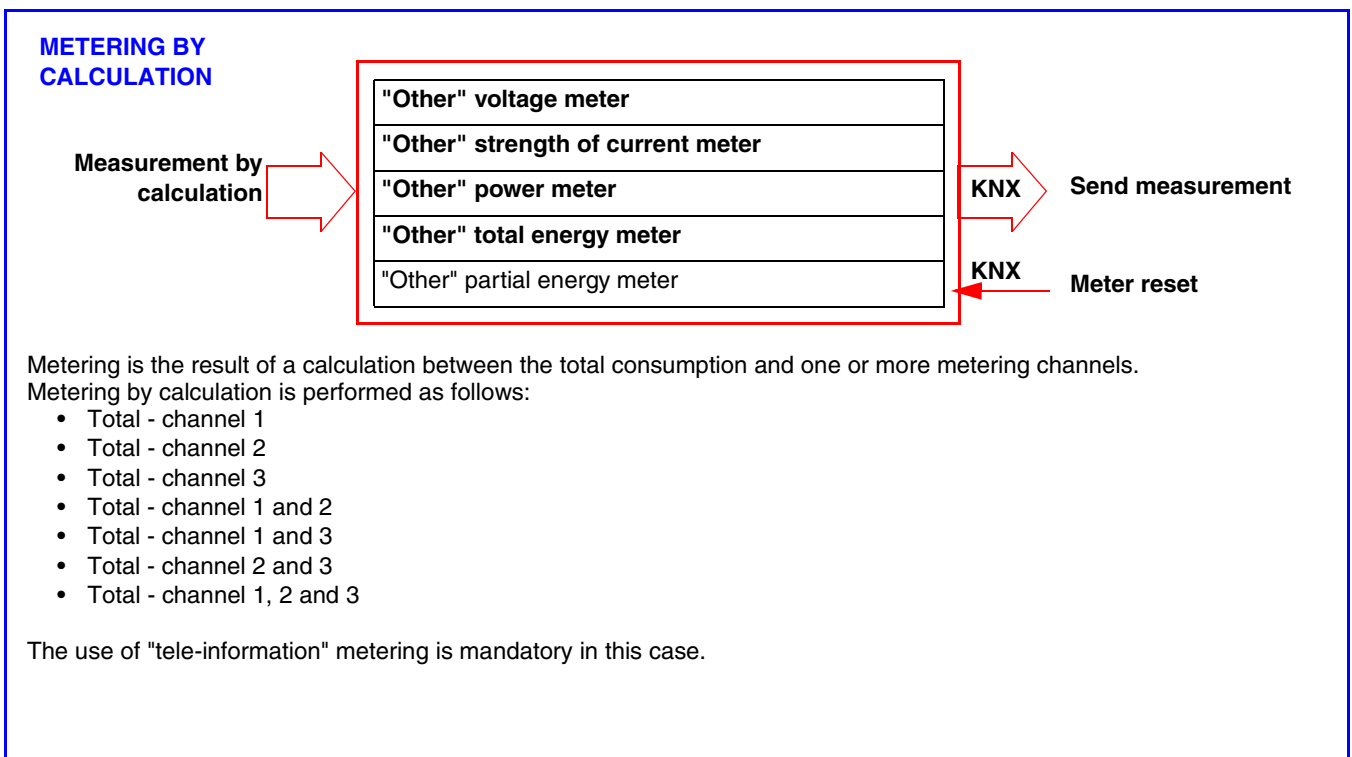

- 1 three-phase measurement channel

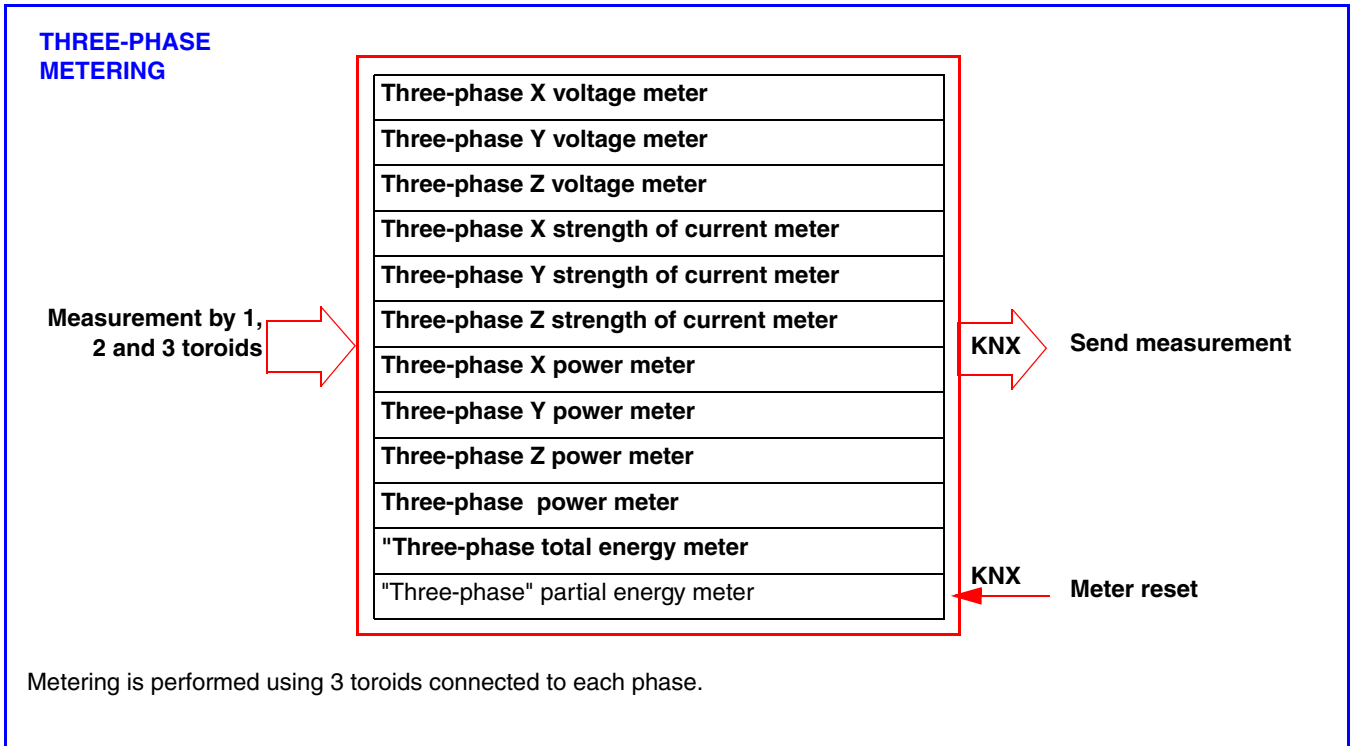

■ Installation type

This product can be used in a single-phase or three-phase installation. In unbalanced three-phase, consumption is measured on each phase. In balanced three-phase, consumption can be measured on one phase only. The measurement is an absolute value.

The measurement channels are used to meter either consumption of energy production (e.g. in the case of a photovoltaic installation).

It is the display system (in domovea for example) which defines the display of consumption or energy production.

■ Precaution for connection

Voltage measurement is performed between a phase and neutral. Each toroid can meter a current up to 90 A. It is possible to pass several conductors in one toroid. The metering channel CT_x is referenced to the L_x phase, CT_y to the L_y phase and CT_z to the L_z phase.

In the single-phase version, it is essential to bridge phases L_y and L_z when outputs CT_y and CT_z are used for metering. Straps are provided for this bridging.

(See chapter 5.4 for all the connection cases).

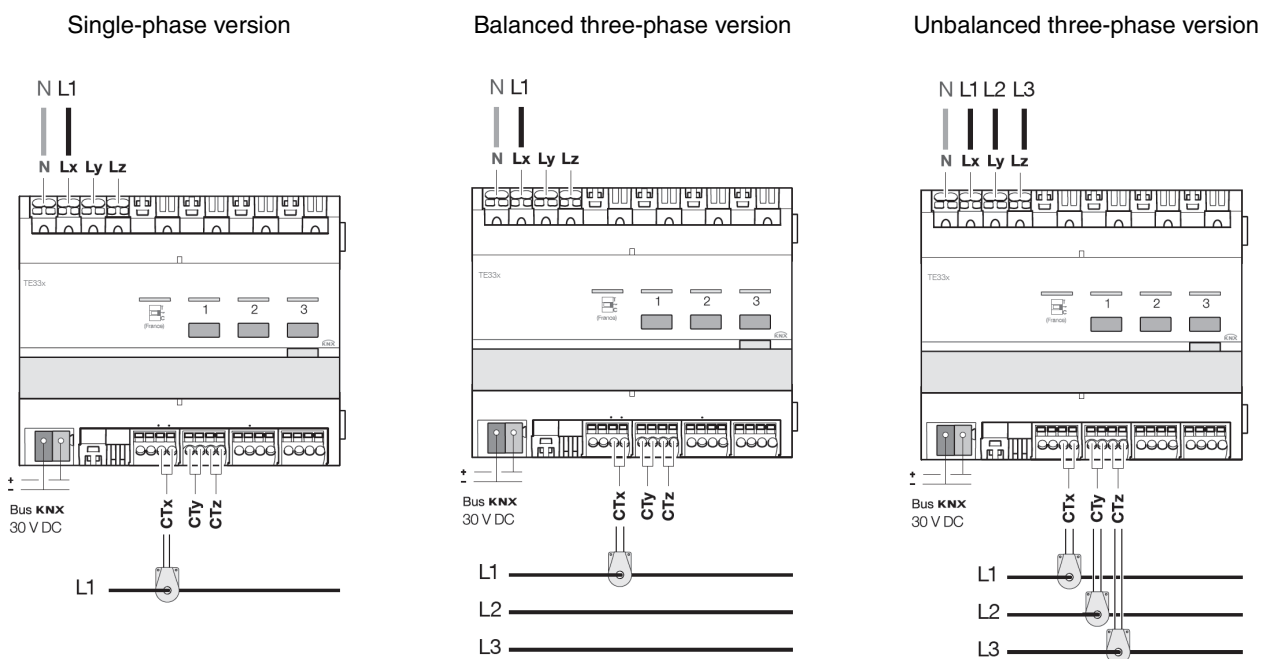

■ Reset

The total energy is the energy counted since the product was installed and cannot be reset. The partial energy can be reset manually by the user using a control on the KNX bus.

■ Last mode stored

Only the indexes for the current total and partial energies are saved in the TE331.

■ Updating the data

The metering channels give the instantaneous power and the total and partial energy. This data is sent when the value changes or periodically.

2.3 Possible installations

Possible installations are given below for the configuration of the electricity metering channels only.

Installation type	Input x	Input y	Input z	Additional settings
Electrical heating + DHW boiler OR Heat pump + DHW boiler	Heating	DHW	Sockets	/
2 in 1 heat pump (Heating + DHW)	Heating / DHW	Not used or sockets or others*	Sockets	Heating / cooling dates (See settings)
3 in 1 heat pump (Heating + Cooling + DHW)	Heating / Cooling / DHW	Not used or sockets or others*	Sockets	Heating / cooling dates (See settings) DHW distribution key (Installer settings)
Reversible heat pump with separate DHW production	Heating / Cooling	DHW	Sockets	Heating / cooling dates (See settings)
Heating and DHW production other than electrical	Not used or sockets or others*	Not used or sockets or others*	Not used or sockets or others*	/

* Inputs x, y and z can be allocated to Sockets or Others use to possibly benefit from additional sub-metering:

- Possible values for Sockets: different socket circuits
- Possible values for Others: different lighting, pump or CMV circuits

■ Example 1: Electric heating and electric DHW or heat pump + DHW boiler

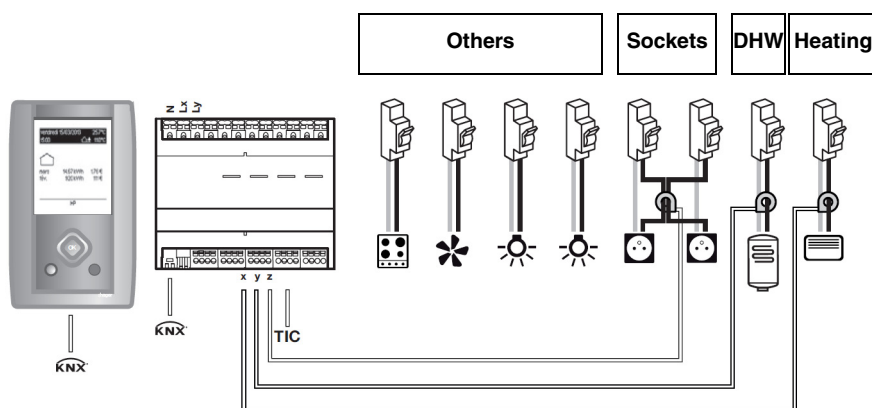

Channel settings:
Channel x: Heating
Channel y: DHW
Channel z: Sockets

Others = TIC* - (Heating + DHW + Sockets)

* Client Tele-Information

■ Example 2: 2 in 1 heat pump (Heating + DHW)

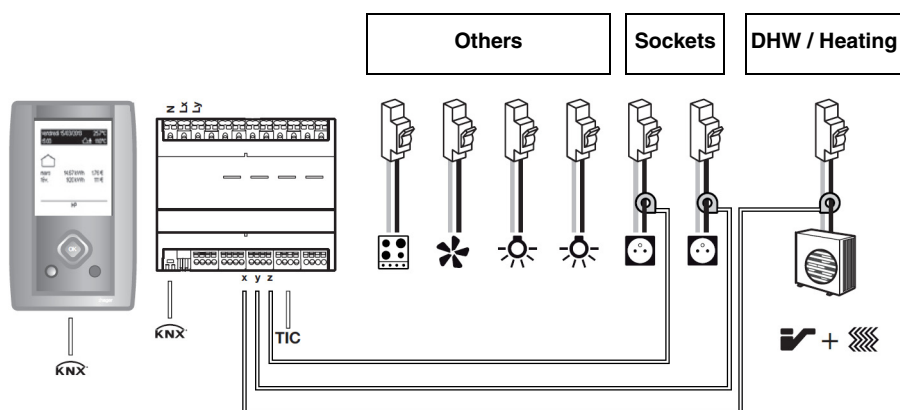

Channel settings:

Channel x: Heating / DHW

Channel y: Sockets with, for example, Ground floor sockets as a label

Channel z: Sockets with, for example, First floor sockets as a label

Others = TIC* - (Heating + DHW + Sockets)

■ Example 3: Heating and DHW production other than electrical

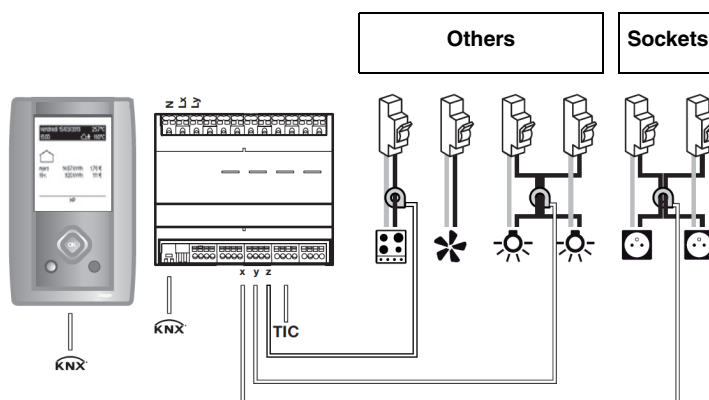

Channel settings:

Channel x: Sockets

Channel y: Others with for example Lighting as a name

Channel z: Others with for example Cooking as a name

Others = TIC* - (Sockets)

* Client Tele-Information

2.4 "Tele-information" tariff

The "Tele-information" link is a standardised bus **used only in France** which is used to connect electricity management equipment to one's electronic meter (EDF). It uses the data available in the meter such as the tariff option subscribed to, the power subscribed to and the consumption data.

By connecting this interface to equipment, it is possible to monitor the development of one's consumption in real time, to calculate costs or control equipment according to the tariff.

2.5 Description of temperature measurement

The function allows the temperature to be measured with an indoor (Ref: EK089) or outdoor (Ref: EK088) temperature sensor. This additional input has no connection with consumption measurement. It is used to measure temperature without adding additional devices to the KNX bus and send the measurement to a display interface (measurement range: -30°C to +70°C).

2.6 Tariff management for the product: with or without tariff

There are 2 different function types:

- Tariff metering:
 - Each channel sends the energy value per tariff,
 - This object is in 6 byte format.

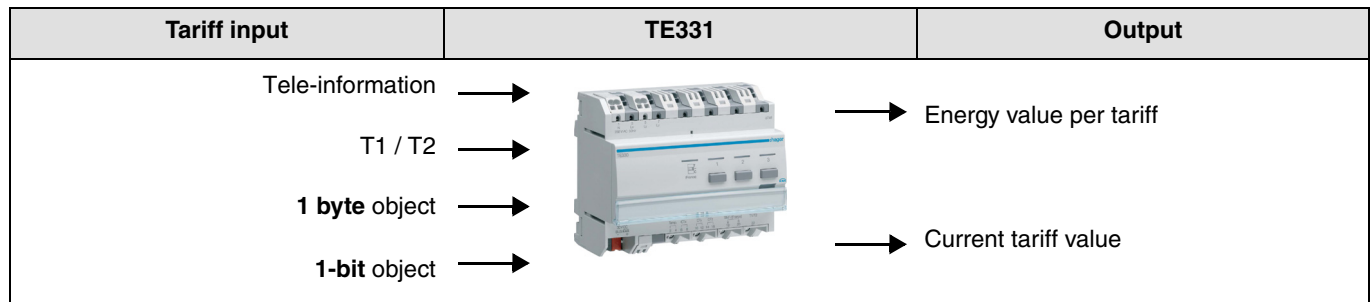

- Metering without tariff:
 - Each channel sends the overall value of the energy without the tariff,
 - This object is in 4 byte format.

Remark: The product is used to send the tariff on the bus based on the "Tele-information" or "T1/T2" inputs.

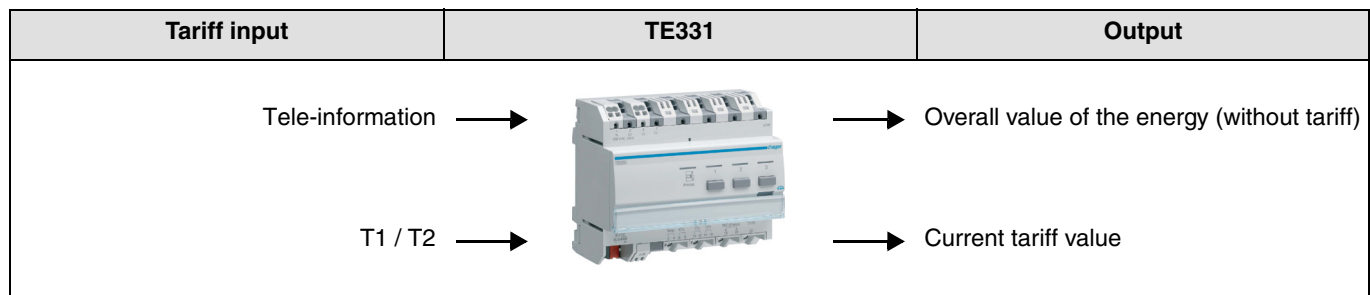

2.7 Contract power exceeded

The function is used to detect when the electrical power contracted from the energy supplier is exceeded. Connection to the télé-info link of the subscriber's meter is mandatory for this function.

The **Tele-info metering - Contract power exceeded** object is transmitted cyclically according to a configurable delay.

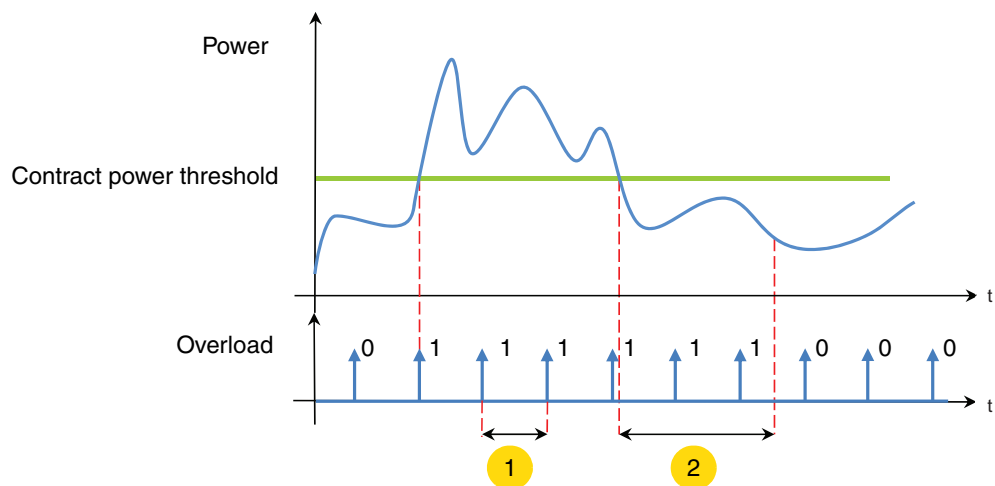

- 1 Contract power exceeded emission every X seconds (configurable duration)
- 2 Emission delay after contract power exceeded

Remark: The polarity of the **Tele-info metering - Contract power exceeded** object is configurable.

3. Configuration and settings

3.1 Objects List

N°	Name	Function of the object	Length	C	R	W	T	
0	Current tariff	Emission	1 byte	C	R	-	T	
1	Coming tariff	Emission	3 bytes	C	R	-	T	(2)
3	Télé-info metering input	Power	4 bytes	C	R	-	T	(2)
4	Télé-info metering input	Total energy	6 bytes	C	R	-	T	(2)
5	Télé-info metering input	Dynamic mode activation	1 bit	C	R	W	-	(2)
6	Partial meter Reset input télé-info activation	Control	1 bit	C	R	W	-	(2)
7	Télé-info metering input	Partial energy	6 bytes	C	R	-	T	(2)
8	Metering input 1	Current tariff	1 byte	C	R	W	-	
9	Metering input 1	Power	4 bytes	C	R	-	T	(1)
10	Metering input 1	Total energy	6 bytes	C	R	-	T	
11	Metering input 1	Dynamic mode activation	1 bit	C	R	W	-	
12	Activation partial meter reset Input 1	Control	1 bit	C	R	W	-	
13	Metering input 1	Partial energy	6 bytes	C	R	-	T	
14	Metering input 2	Current tariff	1 byte	C	R	W	-	
15	Metering input 2	Power	4 bytes	C	R	-	T	(1)
16	Metering input 2	Total energy	6 bytes	C	R	-	T	
17	Metering input 2	Dynamic mode activation	1 bit	C	R	W	-	
18	Activation partial meter reset Input 2	Control	1 bit	C	R	W	-	
19	Metering input 2	Partial energy	6 bytes	C	R	-	T	
20	Metering input 3	Current tariff	1 byte	C	R	W	-	
21	Metering input 3	Power	4 bytes	C	R	-	T	(1)
22	Metering input 3	Total energy	6 bytes	C	R	-	T	
23	Metering input 3	Dynamic mode activation	1 bit	C	R	W	-	
24	Activation partial meter reset Input 3	Control	1 bit	C	R	W	-	
25	Metering input 3	Partial energy	6 bytes	C	R	-	T	
26	Three-phase load metering	Current tariff	1 byte	C	R	W	-	
27	Three-phase load metering	Power	4 bytes	C	R	-	T	
28	Three-phase load metering	Total energy	6 bytes	C	R	-	T	
29	Three-phase load metering	Dynamic mode activation	1 bit	C	R	W	-	
30	Partial meter reset three-phase input	Control	1 bit	C	R	W	-	
31	Three-phase input metering	Partial energy	6 bytes	C	R	-	T	
32	Addition metering	Current tariff	1 byte	C	R	W	-	
33	Addition metering	Power	4 bytes	C	R	-	T	
34	Addition metering	Total energy	6 bytes	C	R	-	T	
35	Addition metering	Dynamic mode activation	1 bit	C	R	W	-	
36	Partial meter reset addition	Control	1 bit	C	R	W	-	
37	Addition metering	Partial energy	6 bytes	C	R	-	T	
38	Other metering	Current tariff	1 byte	C	R	W	-	
39	Other metering	Power	4 bytes	C	R	-	T	
40	Other metering	Total energy	6 bytes	C	R	-	T	
41	Other metering	Dynamic mode activation	1 bit	C	R	W	-	
42	Partial meter reset others	Control	1 bit	C	R	W	-	
43	Other metering	Partial energy	6 bytes	C	R	-	T	

N°	Name	Function of the object	Length	C	R	W	T	
44	Temperature	Emission	2 bytes	C	R	-	T	
47	Télé-info metering input	Total energy T1	4 bytes	C	R	-	T	(2)
48	Télé-info metering input	Total energy T2	4 bytes	C	R	-	T	(2)
49	Télé-info metering input	Total energy T1+T2	4 bytes	C	R	-	T	(2)
50	Télé-info metering input	Partial energy T1	4 bytes	C	R	-	T	(2)
51	Télé-info metering input	Partial energy T2	4 bytes	C	R	-	T	(2)
52	Télé-info metering input	Partial energy T1+T2	4 bytes	C	R	-	T	(2)
53	Télé-info metering input	Voltage	4 bytes	C	R	-	T	(2)
54	Télé-info metering input	Strength	4 bytes	C	R	-	T	(2)
55	Metering input 1	Total energy T1	4 bytes	C	R	-	T	
56	Metering input 1	Total energy T2	4 bytes	C	R	-	T	
57	Metering input 1	Total energy T1+T2	4 bytes	C	R	-	T	
58	Metering input 1	Partial energy T1	4 bytes	C	R	-	T	
59	Metering input 1	Partial energy T2	4 bytes	C	R	-	T	
60	Metering input 1	Partial energy T1+T2	4 bytes	C	R	-	T	
61	Metering input 1	Voltage	4 bytes	C	R	-	T	(1)
62	Metering input 1	Strength	4 bytes	C	R	-	T	(1)
63	Metering input 2	Total energy T1	4 bytes	C	R	-	T	
64	Metering input 2	Total energy T2	4 bytes	C	R	-	T	
65	Metering input 2	Total energy T1+T2	4 bytes	C	R	-	T	
66	Metering input 2	Partial energy T1	4 bytes	C	R	-	T	
67	Metering input 2	Partial energy T2	4 bytes	C	R	-	T	
68	Metering input 2	Partial energy T1+T2	4 bytes	C	R	-	T	
69	Metering input 2	Voltage	4 bytes	C	R	-	T	(1)
70	Metering input 2	Strength	4 bytes	C	R	-	T	(1)
71	Metering input 3	Total energy T1	4 bytes	C	R	-	T	
72	Metering input 3	Total energy T2	4 bytes	C	R	-	T	
73	Metering input 3	Total energy T1+T2	4 bytes	C	R	-	T	
74	Metering input 3	Partial energy T1	4 bytes	C	R	-	T	
75	Metering input 3	Partial energy T2	4 bytes	C	R	-	T	
76	Metering input 3	Partial energy T1+T2	4 bytes	C	R	-	T	
77	Metering input 3	Voltage	4 bytes	C	R	-	T	(1)
78	Metering input 3	Strength	4 bytes	C	R	-	T	(1)
79	Three-phase input metering	Total energy T1	4 bytes	C	R	-	T	
80	Three-phase input metering	Total energy T2	4 bytes	C	R	-	T	
81	Three-phase input metering	Total energy T1+T2	4 bytes	C	R	-	T	
82	Three-phase input metering	Partial energy T1	4 bytes	C	R	-	T	
83	Three-phase input metering	Partial energy T2	4 bytes	C	R	-	T	
84	Three-phase input metering	Partial energy T1+T2	4 bytes	C	R	-	T	
87	Addition metering	Total energy T1	4 bytes	C	R	-	T	
88	Addition metering	Total energy T2	4 bytes	C	R	-	T	
89	Addition metering	Total energy T1+T2	4 bytes	C	R	-	T	
90	Addition metering	Partial energy T1	4 bytes	C	R	-	T	
91	Addition metering	Partial energy T2	4 bytes	C	R	-	T	
92	Addition metering	Partial energy T1+T2	4 bytes	C	R	-	T	
93	Addition metering	Voltage	4 bytes	C	R	-	T	
94	Addition metering	Strength	4 bytes	C	R	-	T	
95	Other metering	Total energy T1	4 bytes	C	R	-	T	
96	Other metering	Total energy T2	4 bytes	C	R	-	T	
97	Other metering	Total energy T1+T2	4 bytes	C	R	-	T	
98	Other metering	Partial energy T1	4 bytes	C	R	-	T	
99	Other metering	Partial energy T2	4 bytes	C	R	-	T	

N°	Name	Function of the object	Length	C	R	W	T	
100	Other metering	Partial energy T1+T2	4 bytes	C	R	-	T	
101	Other metering	Voltage	4 bytes	C	R	-	T	
102	Other metering	Strength	4 bytes	C	R	-	T	
103	1 byte tariff	Reception	1 byte	C	R	W	-	
105	1 bit Tariff	Reception	1 bit	C	R	W	-	
106	Télé-info metering input	Contract power exceeded	1 bit	C	R	-	T	

(1) These Objects are also used for three-phase metering.

(2) Only for France.

Designation	Function	Value
Current tariff	<p>The Current tariff – Emission object is a value sent by the TE331 module on the bus for display and indexing of the energy values. The object is used to publish on the bus the current tariff received by the physical tele-information input or T1 / T2.</p> <p>The input must be configured between (See paragraph 3.2):</p> <p>Tele-information: (Only for France) 0 = Basic tariff 1 = Heures creuses (HC) 2 = Heures pleines (HP) 3 = EJP 4 = EJP Pointe mobile 5 = Bleu heures creuses (bleu HC) 6 = Blanc heures creuses (blanc HC) 7 = Rouge heures creuses (rouge HC) 8 = Bleu heures pleines (bleu HP) 9 = Blanc heures pleines (blanc HP) 10 = Rouge heures pleines (rouge HP)</p> <p>T1 / T2: 0 = T1 or Heures Pleines (HP) 1 = T2 or Heures Creuses (HC)</p> <p>When several TE331 are installed on the same bus, the Current tariff - Emission object must be linked to the 1 byte tariff – Reception.</p>	1 byte
Coming tariff	<p>The Coming tariff – Emission object is a value sent by the TE331 module on the bus for display.</p> <p>The data comes from the tele-information and is only available in this case of application.</p> <p>Only for France ("Tele-information Setting") 0 = Basic tariff 1 = Heures creuses (HC) 2 = Heures pleines (HP) 3 = EJP 4 = EJP Pointe mobile 5 = Bleu heures creuses (bleu HC) 6 = Blanc heures creuses (blanc HC) 7 = Rouge heures creuses (rouge HC) 8 = Bleu heures pleines (bleu HP) 9 = Blanc heures pleines (blanc HP) 10 = Rouge heures pleines (rouge HP) + Indication of the duration in minutes before changeover</p>	3 bytes
Metering power	The Metering Input x – Power object is a value sent on the bus.	4 bytes
Total metering energy	The Metering Input x – Total energy object is a value sent on the bus.	6 bytes / 4 bytes
Dynamic mode	<p>The Metering Input x – Activation dynamic mode object is information received from the input module. When the user consults the consumption pages on the input module or the domovea server, the consumption data displayed on the screen is refreshed at the highest frequency. 0 = Stopping of dynamic mode 1 = Start-up of dynamic mode</p>	1 bit
Partial meter reset	<p>The Activation partial meter reset Input x – Control object is a control received from the input module. 0 = No reset 1 = Partial meter reset</p>	1 bit
Partial energy metering	The Metering Input x – Partial energy object is a value sent on the bus. (Value in Wh)	6 bytes / 4 bytes
Metering voltage	The Metering Input x – Voltage object is a value sent on the bus. (Value in volts)	4 bytes
Metering current	The Metering Input x – Current is a value sent on the bus. (Value in amperes)	4 bytes

Designation	Function	Value
1 byte tariff	<p>The 1 byte tariff - Reception is a value received from the bus. The object is used to cascade several TE331 in the same installation. It can be linked to the Current tariff - Emission object of another TE331.</p> <p>The values of the object are: 0 = Tariff 0 1 = Tariff 1 2 = Tariff 2 3 = Tariff 3 4 = Tariff 4 5 = Tariff 5 6 = Tariff 6 7 = Tariff 7 8 = Tariff 8 9 = Tariff 9 10 = Tariff 10</p>	1 byte
1 bit Tariff	<p>The 1 byte tariff - Reception is a value received from the bus. 0 = T1 or Basic tariff 1 = T2 or Heures Creuses (HC)</p>	1 bit
Metering current tariff	<p>The Metering Input x - Current tariff is a value received from the bus. The object is used to allocate a different tariff to each channel.</p>	1 byte
Temperature	<p>The Temperature - Emission is a value sent by the TE331 module when a probe is connected. The temperature is sent on the bus for display.</p>	2 bytes
Contract power exceeded	<p>The Tele-info Input metering - Contract power exceeded object is a value emitted by the TE331 module if the contract electrical power is exceeded. The polarity of the object is configurable.</p>	1 bit

3.2 General parameters

→ Parameter Setting screen

<ul style="list-style-type: none"> General Télé-info input metering Input 1 metering Input 2 metering Input 3 metering Addition metering Other metering Information 	<p>Energy object format: 6 bytes (energy + tariff information)</p> <p>Tariff input selection: Télé-info (France)</p> <p>Metering: Single-phase/balanced three-phase</p> <p>Emission of tariff every: 5 min</p> <p>Temperature emission by variation of (x0,01°C): 50</p> <p>Temperature periodical emission: 15 min</p> <p>Contract power exceeded polarity: 0= > contract power, 1 = < contract power</p> <p>Contract power exceeded emission every: Not active</p> <p>Emission delay after contract power exceeded: 15 min</p>
---	--

→ Parameters

Designation	Function	Value
Energy object format	This parameter defines the type of metering of the Energy objects used by the product for the metering channels. (refer to chapter 2.5)	6 byte (energy + tariff information) 4 byte (energy only) Default value: 6 byte (energy + tariff information)
Tarif input selection	This parameter defines the type of tariff used by the product for the metering channels. (refer to chapter 2.4)	Tele-info (France) T1 / T2 (Double tariff HP / HC) 1 byte object 1-bit object Default value: Tele-info (France)
Metering	This parameter defines the metering mode used.	Single-phase / Balanced three-phase / Three-phase Default value: Single-phase / Balanced three-phase
Emission of tariff every	This parameter defines the refreshment period for the current tariff value.	Range [60 s - 24 h]* Default value: 5 min
Temperature emission by variation of (x0.01°C)	This parameter defines the emission threshold for the Temperature object.	Range [10 - 1000] Default value: 50 (50 * 0.01°C = 0.5°C)
Contract power exceeded polarity	This parameter defines the polarity of the Tele-info Input metering - Contract power exceeded object if the power measured by the energy supplier's meter is higher or lower than the contract power.	0= > contract power, 1 = < contract power 0= < contract power, 1 = > contract power Default value: 0= > contract power, 1 = < contract power
Contract power exceeded emission every	This parameter defines the frequency of emission of the Tele-info Input metering - Contract power exceeded object.	Range [1 s - 24 h]** Default value: Not active

Designation	Function	Value
Emission delay after contract power exceeded	This parameter defines the duration after which the Tele-info input metering - Contract power exceeded object changes status after the power measured by the energy supplier's meter falls below the contract power (refer to chapter 2.7).	Range [1 s - 24 h]** Default value: 15 min

* Setting range [60 s - 24 h]

Not active, 60 s, 1 min 15 s, 1 min 30 s, 2 min, 2 min 30 s, 3 min, 5 min, 15 min, 20 min, 30 min, 1 h, 2 h, 3 h, 5 h, 12 h, 24 h.

** Setting range [1 s - 24 h]

Not active, 1 s, 2 s, 3 s, 5 s, 10 s, 15 s, 20 s, 30 s, 45 s, 60 s, 1 min 15 s, 1 min 30 s, 2 min, 2 min 30 s, 3 min, 5 min, 15 min, 20 min, 30 min, 1 h, 2 h, 3 h, 5 h, 12 h, 24 h.

When the **Tariff input selection** parameter has the value **T1 / T2 (Double tariff HP / HC)**, the following additional parameters appear:

Designation	Function	Value
Value of tariff index T1	This parameter defines the value of the index to be applied for the tariff input T1.	Range [1 - 10] Default value: 1
Value of tariff index T2	This parameter defines the value of the index to be applied for the tariff input T2.	Range [1 - 10] Default value: 2

The value of the tariff index must be adjusted according to the chosen tariff or selected country.

Remark: **Tariff** object under ETS:

- The **Tariff** object is used to allocate an index to the energy meter,
- A **Tariff** object is distinguished for the product and for each metering channel.

- Case of the tariff for the product: the chosen tariff is allocated to all the channels.

There are 4 statuses:

- Tele-info (Only for France) (Default value): Only used in French installations with an electronic electricity meter,
- T1 / T2 (Double tariff HP / HC): Used in all installations having a meter with a tariff output for which the characteristics are compatible T1 = 0 V, T2 = 230 V ± 15%,
- **1 byte** object: Used in installations having an external tariff in 1 byte format sent on the KNX bus,
- **1-bit** object: Used in installations having an external tariff in 1 bit format sent on the KNX bus.

By selecting the "Tele-info" or "T1 / T2", the consumption indicator sends the tariff on the KNX bus. If not, it receives the tariff from an external device via the KNX bus.

When modifying settings (e.g.change from "Tele-info" to 1 byte object) on a link already in place, ETS erases the object and breaks the link.

The following message appears on the screen:

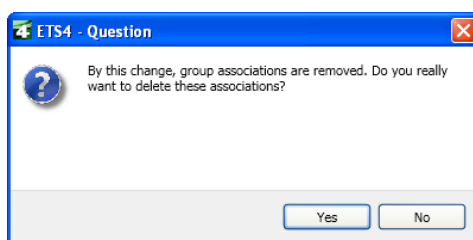

Confirm by "yes" to validate your choice. Then create the link with the new object.

- Case of a tariff for each channel: the selected tariff is only allocated to the channel.

There are 3 statuses:

- No Change (Default function): The tariff used is that of the product,
- Not used: The channel does not use the tariff information. The energy values are not indexed,
- **Current tariff metering** object: A new tariff object is available for the channel. It is different to the tariff for the product. This provides another tariff band to that for the product.

If several links are made to the **1 byte tariff – Reception** object, the last tariff received is the one taken into account.

3.3 Metering input

3.3.1 Télé-info metering input

→ Parameter Setting screen

General Télé-info input metering Input 1 metering Input 2 metering Input 3 metering Addition metering Other metering Information	Tariff input selection Emission of power by variation of (W) Emission of power (dynamic mode) by variation of (W) Dynamic mode duration Emission total energy by variation of (Wh) Emission partial energy by variation of (Wh) Emission of power every Emission of energy every Voltage emission by variation of Voltage emission every Strength of current emission by variation of Strength of current emission every	Tariff input value from general thumbnail 500 10 15 min 100 100 5 min 2 min 30 s 5 V 5 min 2 A 5 min
--	---	---

→ Parameters

Designation	Function	Value
Tariff input selection	<p>This parameter defines the type of tariff used by the metering channel (refer to chapter 3.2).</p> <p>No Change: The tariff used is that defined in the general tab and allocated to all the metering channels. Not used: The tariff information is not used. The meter counts the basic tariff. Current tariff metering object: When this parameter is selected the metering channel can receive a different tariff to that selected in the general tab and allocated to all the metering channels.</p> <p>The Metering input x – Current tariff object appears in the list of objects for the channel in question.</p>	No Change Not used Current tariff metering object Default value: No Change
Emission of power by variation of input (W)	This parameter defines the Power object transmission threshold.	Range [0 - 1000000] Default value: 500
Emission of power (dynamic mode) by variation of input (W)	This parameter defines the threshold for the emission of Power objects in dynamic mode (during Dynamic mode activation).	Range [0 - 1000000] Default value: 50
Dynamic mode duration	This parameter defines the frequency for emission of Dynamic mode activation objects.	Range [60 s - 24 h]* Default value: 15 min
Emission total energy by variation of input (Wh)	This parameter defines the threshold for emission of Total energy objects.	Range [0 - 1000000] Default value: 100

Designation	Function	Value
Emission partial energy by variation of (Wh)	This parameter defines the threshold for emission of Partial energy objects.	Range [0 - 1000000] Default value: 100
Emission of power every	This parameter defines the Power object transmission frequency.	Range [60 s - 24 h]* Default value: 5 min
Emission of energy every	This parameter defines the frequency of emission of Energy objects.	Range [60 s - 24 h]* Default value: 2 min 30 s
Emission of voltage by variation of the input	This parameter defines the threshold for emission of Voltage objects.	Range [1 V - 35 V] Default value: 5 V
Voltage emission every	This parameter defines the frequency of emission of Voltage objects.	Range [60 s - 24 h]* Default value: 5 min
Emission of current by variation of the input	This parameter defines the threshold for emission of Current objects.	Range [0.1 A - 20 A]** Default value: 2 A
Strength emission every	This parameter defines the frequency of emission of Current objects.	Range [60 s - 24 h]* Default value: 5 min

* Setting range [60 s - 24 h]

Not active, 60 s, 1 min 15 s, 1 min 30 s, 2 min, 2 min 30 s, 3 min, 5 min, 15 min, 20 min, 30 min, 1 h, 2 h, 3 h, 5 h, 12 h, 24 h.

** Setting range [0.1 A - 20 A]

0.1 A, 0.5 A, 1 A, 2 A, 3 A, 4 A, 5 A, 6 A, 7 A, 8 A, 9 A, 10 A, 11 A, 12 A, 13 A, 14 A, 15 A, 16 A, 17 A, 18 A, 19 A, 20 A.

3.3.2 Input 1 to 3 metering

→ Parameter Setting screen

<ul style="list-style-type: none"> General Télé-info input metering <li style="border: 1px solid blue;">Input 1 metering Input 2 metering Input 3 metering Addition metering Other metering Information 	<p>Channel metering Used channel ▼</p> <p>Tariff input selection Tariff input value from general thumbnail ▼</p> <p>Metering Single-phase ▼</p> <p>Emission of power by variation of (W) 500 ▲▼</p> <p>Emission of power (dynamic mode) by variation of (W) 10 ▲▼</p> <p>Dynamic mode duration 15 min ▼</p> <p>Emission total energy by variation of (Wh) 100 ▲▼</p> <p>Emission partial energy by variation of (Wh) 100 ▲▼</p> <p>Emission of power every 5 min ▼</p> <p>Emission of energy every 2 min 30 s ▼</p> <p>Voltage emission by variation of 5 V ▼</p> <p>Voltage emission every 5 min ▼</p> <p>Strength of current emission by variation of 2 A ▼</p> <p>Strength of current emission every 5 min ▼</p>
---	---

→ Parameters

Designation	Function	Value
Channel metering	<p>This parameter defines the Using mode for the metering channel.</p> <p>Used channel: The objects linked to the metering channel are displayed.</p> <p>Channel used for calculation only: the objects linked to the metering channel are masked. The channel is used to calculate the metering of the addition or others channel.</p> <p>Not used channel: the objects linked to the metering channel are masked.</p>	<p>Used channel Channel used for calculation only Not used channel</p> <p>Default value: Used channel</p>
Metering	<p>This parameter defines the metering method of the channel.</p>	<p>Single-phase Balanced three-phase</p> <p>Default value: Single-phase</p>

The other parameters are identical to the Tele-info metering channel (refer to chapter 3.6.1).

Balanced three-phase metering consists of a measurement on one phase. Indeed, for the measurement of a three-phase motor, the consumption of the 3 phases is identical. The various elements measured (Power, energy, etc.) simply need to be multiplied by 3 to obtain the desired metering.

Balanced three-phase metering	Calculation
Power	= 3 * Power input 1, 2 or 3
Total energy	= 3 * Total energy input 1, 2 or 3
Partial energy	= 3 * Partial energy input 1, 2 or 3
Voltage	= Voltage input 1, 2 or 3
Strength	= 3 * Strength input 1, 2 or 3

Activation of dynamic mode and partial reset of the meter are dedicated solely to this metering. They remain independent of inputs 1, 2 and 3.

3.3.3 Addition metering

→ Parameter Setting screen

<ul style="list-style-type: none"> General Télé-info input metering Input 1 metering Input 2 metering Input 3 metering <li style="border: 1px solid #00aaff; padding: 2px;">Addition metering Other metering Information 	<p>Channel addition configuration Channel 1 + 2 ▼</p> <p>Tariff input selection Tariff input value from general thumbnail ▼</p> <p>Emission of power by variation of (W) 500 ▲▼</p> <p>Emission of power (dynamic mode) by variation of (W) 10 ▲▼</p> <p>Dynamic mode duration 15 min ▼</p> <p>Emission total energy by variation of (Wh) 100 ▲▼</p> <p>Emission partial energy by variation of (Wh) 100 ▲▼</p> <p>Emission of power every 5 min ▼</p> <p>Emission of energy every 2 min 30 s ▼</p> <p>Voltage emission by variation of 5 V ▼</p> <p>Voltage emission every 5 min ▼</p> <p>Strength of current emission by variation of 2 A ▼</p> <p>Strength of current emission every 5 min ▼</p>
--	--

→ Parameters

Designation	Function	Value
Channel addition configuration	This parameter defines which physical channels are used for the addition channel.	Not active Channel 1+2 Channel 1+3 Channel 2+3 Channel 1+2+3 Default value: Not active

The other parameters are identical to the Tele-info metering channel (refer to chapter 3.6.1).

Addition metering	Calculation
Power	= Power input 1 + input 2 + input 3
Total energy	= Total energy input 1 + input 2 + input 3
Partial energy	= Energy measured using the toroids for inputs 1, 2 and 3
Voltage	= Average of the input voltages 1, 2 and 3
Strength	= Strength input 1 + input 2 + input 3

The partial energy meter is based on the 3 consumption channels independently. It does not correspond to the sum of the partial energies of inputs 1, 2 and 3.

Activation of dynamic mode and partial reset of the meter are dedicated solely to this metering. They remain independent of inputs 1, 2 and 3.

3.3.4 Other metering

→ Parameter Setting screen

General	Channel other configuration	Total Télé-info - channel 1 + 2 + 3
Télé-info input metering	Tariff input selection	Tariff input value from general thumbnail
Input 1 metering	Emission of power by variation of (W)	500
Input 2 metering	Emission of power (dynamic mode) by variation of (W)	10
Input 3 metering	Dynamic mode duration	15 min
Addition metering	Emission total energy by variation of (Wh)	100
Other metering	Emission partial energy by variation of (Wh)	100
Information	Emission of power every	5 min
	Emission of energy every	2 min 30 s
	Voltage emission by variation of	5 V
	Voltage emission every	5 min
	Strength of current emission by variation of	2 A
	Strength of current emission every	5 min

→ Parameters

Designation	Function	Value
Channel other configuration	This parameter defines which physical channels are used for subtraction with the total consumption. The use of "tele-information" metering is mandatory in this case.	Not active Tele-inf - Channel 1 Tele-inf - Channel 2 Tele-inf - Channel 3 Tele-inf - Channel 1+2 Tele-inf - Channel 1+3 Tele-inf - Channel 2+3 Tele-inf - Channel 1+2+3 Default value: Tele-inf - Channel 1+2+3

The other parameters are identical to the Tele-info metering channel (refer to chapter 3.6.1).

Addition metering	Calculation
Power	= Total power - power input 1 - power input 2 - power input 3
Total energy	= Total energy - total energy 1 - total energy 2 t total energy 3
Partial energy	= Total energy - energy measured using the toroids for inputs 1, 2 and 3
Voltage	= Total voltage
Strength	= Total strength - strength input 1 - strength input 2 - strength input 3

The partial energy meter is based on the total and the 3 consumption channels independently. It does not correspond to the difference of the total partial energy minus inputs 1, 2 and 3.

Activation of dynamic mode and partial reset of the meter are dedicated solely to this metering. They remain independent of inputs 1, 2 and 3.

3.3.5 Three-phase metering

→ Parameter Setting screen

General	Tariff input selection	Tariff input value from general thumbnail
Télé-info input metering	Emission of power by variation of (W)	500
Three-phase load metering	Emission of power (dynamic mode) by variation of (W)	10
Other metering	Dynamic mode duration	15 min
Information	Emission total energy by variation of (Wh)	100
	Emission partial energy by variation of (Wh)	100
	Emission of power every	5 min
	Emission of energy every	2 min 30 s
	Voltage emission by variation of	5 V
	Voltage emission every	5 min
	Strength of current emission by variation of	2 A
	Strength of current emission every	5 min

The other parameters are identical to the Tele-info metering channel (refer to chapter 3.6.1).

Addition metering	Calculation
Power	= Power input 1 + input 2 + input 3
Total energy	= Total energy input 1 + input 2 + input 3
Partial energy	= Energy measured using the toroids for inputs 1, 2 and 3
Voltage	No voltage available
Strength	= Strength input 1 + input 2 + input 3

The partial energy meter is based on the 3 consumption channels independently. It does not correspond to the sum of the partial energies of inputs 1, 2 and 3.

Activation of dynamic mode and partial reset of the meter are dedicated solely to this metering. They remain independent of inputs 1, 2 and 3.

4. Configuration and use with domovea

The domovea configurator has an "Energy management" type device for the electricity meter.

Functions available:

- **Electrical power:** Used to display the consumed electrical power value (in W).
- **Electrical energy:** Used to display the consumed electrical energy value (in kWh).
- **Tariff indication:** Used to display the current tariff.
- **Dynamic restart:** Used to force send mode for the electrical power value to update the value faster. It is activated for a duration that can be configured in ETS.

4.1 Adding the device

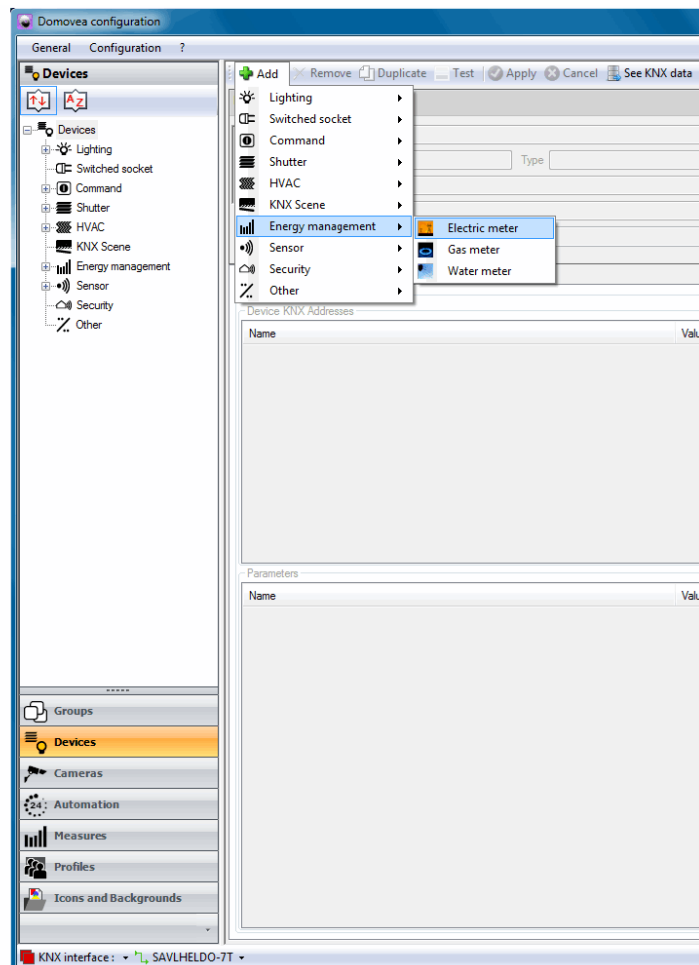

For more details, see the **Energy** document for the domovea system.

4.2 Choice of tariff under domovea

Domovea allows a tariff to be defined according to the offer subscribed to. To do so, click on the "Measurements" tab for the device used, then on "Subscription".

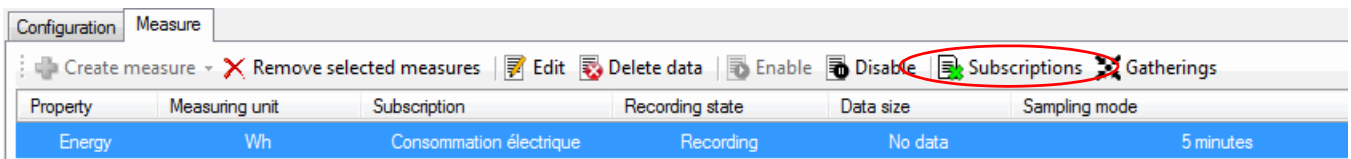

Define your subscription by clicking on "Chose a subscription model".

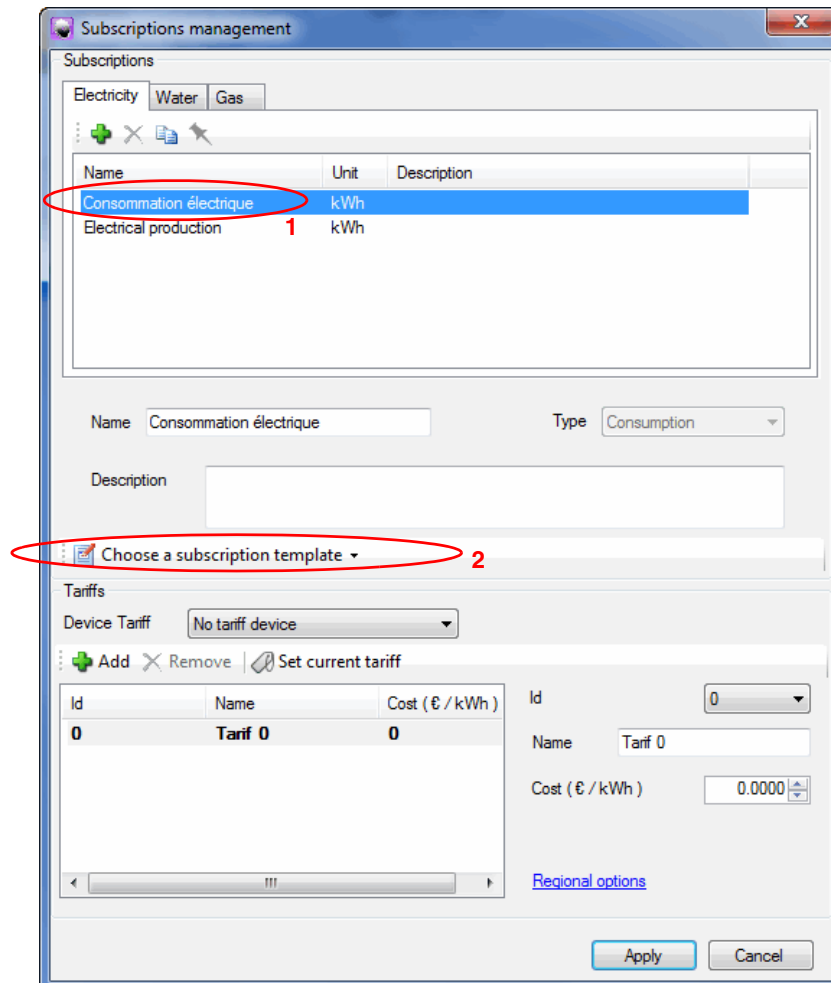

Domovea has tariff models according to the country (France or Germany) and a personalised model (configurable).

For more details, see the **Energy** document for the domovea system.

Type	Option	Identifiant	Name
German	Einzelarif	0	Basic
	Doppeltarif	0	Tarif 1 (More expensive)
		1	Tarif 2
France	Basic	0	Basic
		1	Heure creuse
	Heure pleine / Heure creuse	2	Heure pleine
		Tempo	5
	6		Blanc HC
	7		Red HC
	8		Blue HP
	9		Blanc HP
	10		Red HP
	EJP	3	Normal day
		4	Peak day
Personalised	0	Tarif 0	
	1	Tarif 1	
	2	Tarif 2	
	3	Tarif 3	
	4	Tarif 4	
	5	Tarif 5	
	6	Tarif 6	
	7	Tarif 7	
	8	Tarif 8	
	9	Tarif 9	
	10	Tarif 10	

The cost of each tariff can be configured.

Example for:

- **France:** Using the "Tele-information" input
 - Click on "choice of a subscription model" then on "France" then on "EDF",
 - Define the tariff option between "Basic", "Heures pleines / Heures creuses", "Tempo" or "EJP".
- **France:** Using the T1 / T2 input without "Tele-information"
 - **Use the personalised tariff:**
 - Click on "choice of a subscription model" then "Customised model",
 - Define Tariff name0 as Heures pleines,
 - Define Tariff name 1 as Heures creuses,
 - Delete tariffs 2 to 10 which are not used in this case.
- **Germany:** Use input T1 / T2
 - Click on "choice of subscription model" then on "Germany",
 - Define the tariff option between "Einzelarif" and "Doppeltarif".
- **Other countries: Use the personalised tariff**
 - Click on "choice of a subscription model" then "Customised model",
 - Define the tariff option according to your installation by configuring the tariff 0 to 10.

5. Technical characteristics

5.1 Installation

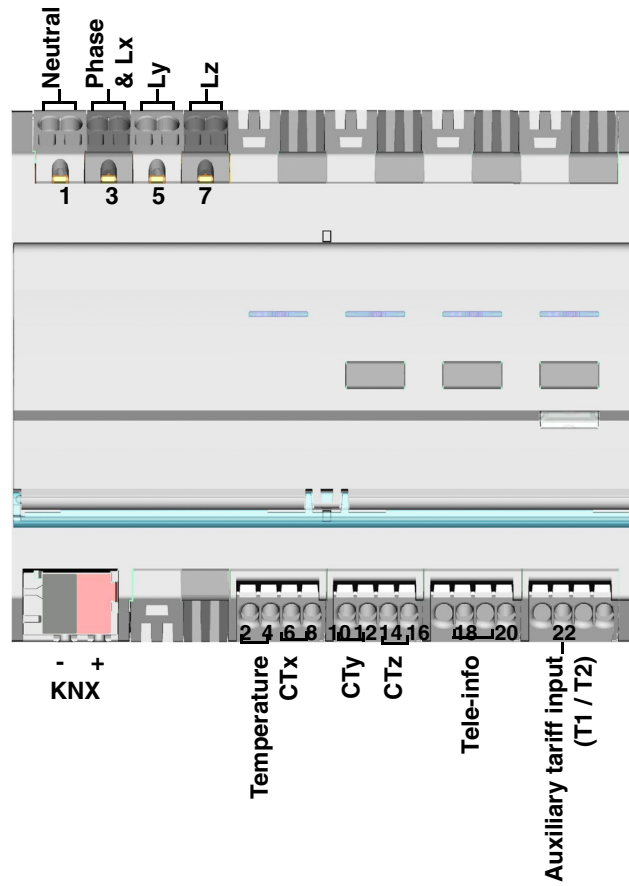

Remark:
The 3 buttons are only used for configuration with the TX100.

5.2 Meaning of the LED's

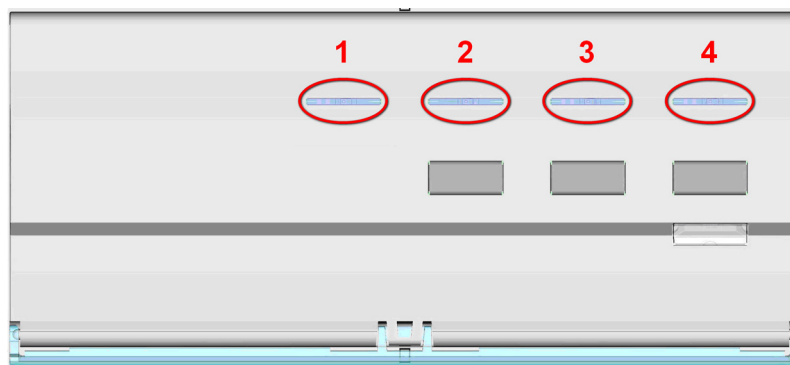

Channel	Function	LED 1	LED 2	LED 3	LED 4
"Tele-information" (Only in France)	Activated	ON	X	X	X
	Deactivated	OFF	X	X	X
	Communication error or error on the channel	Flashing	X	X	X
Channel 1	Operating	X	Flashes for every 1 Wh consumed	X	X
	No bridging in single phase or no phase in three-phase	X	Flashing at a frequency of 0.5 Hz*	X	X
Channel 2	Operating	X	X	Flashes for every 1 Wh consumed	X
	No bridging in single phase or no phase in three-phase	X	X	Flashing at a frequency of 0.5 Hz*	X
Channel 3	Operating	X	X	X	Flashes for every 1 Wh consumed
	No bridging in single phase or no phase in three-phase	X	X	X	Flashing at a frequency of 0.5 Hz*
	No mains power on inputs N and Lx or ETS downloading error	Flashing (1 Hz)	Flashing (1 Hz)	Flashing (1 Hz)	Flashing (1 Hz)

* 0.5 Hz corresponds to 1 s LED ON and 1 s LED OFF.

Remark:

Indication of the presence or absence of a wiring error can take up to one minute.

If a channel is configured as a balanced three-phase channel, the LED flashes three times faster as the consumption is multiplied by three.

5.3 Current outage and return

The consumption indicator requires mains power and a power supply to the KNX bus to operate.

Mains power fault: After 60 s, the energy, current, voltage and power data returns to 0 and is still sent on the bus according to the defined period. When the mains power is restored, the data is sent normally again.

KNX bus fault or mains + KNX bus fault: The consumption indicator is deemed to be out of service. No data is sent. When the bus connection and power supply are restored, the system takes a few minutes to restart and send data normally.

Remark: To address or configure the product, only the KNX bus requires power.

5.4 Connection of the toroids according to the number of phases

→ Single-phase

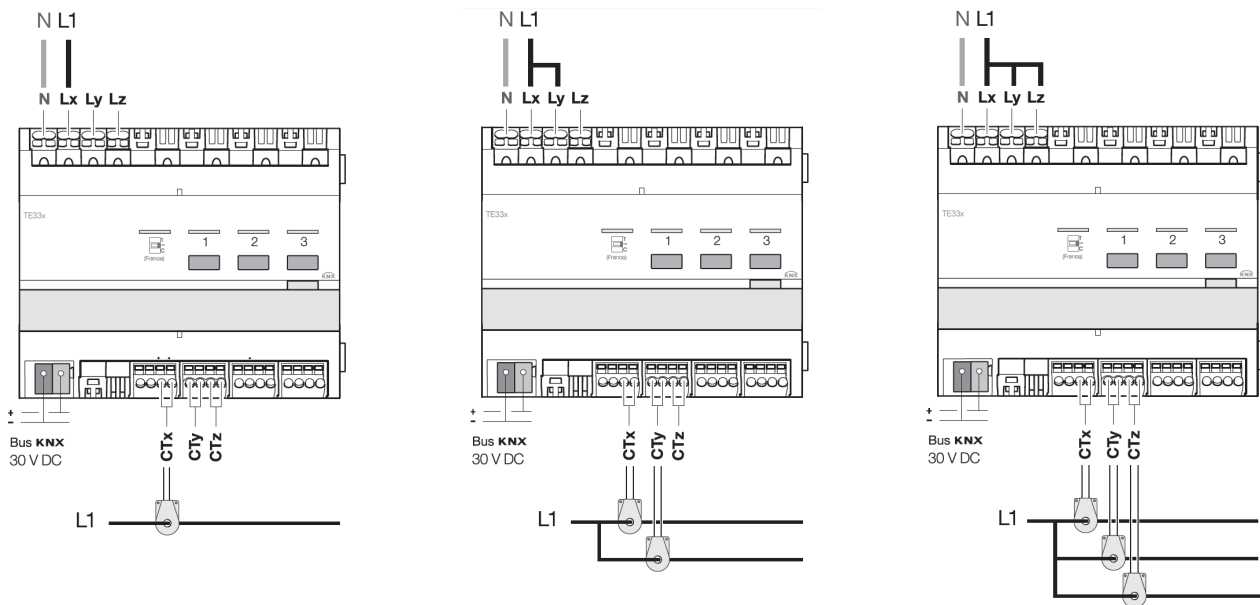

→ Three-phase

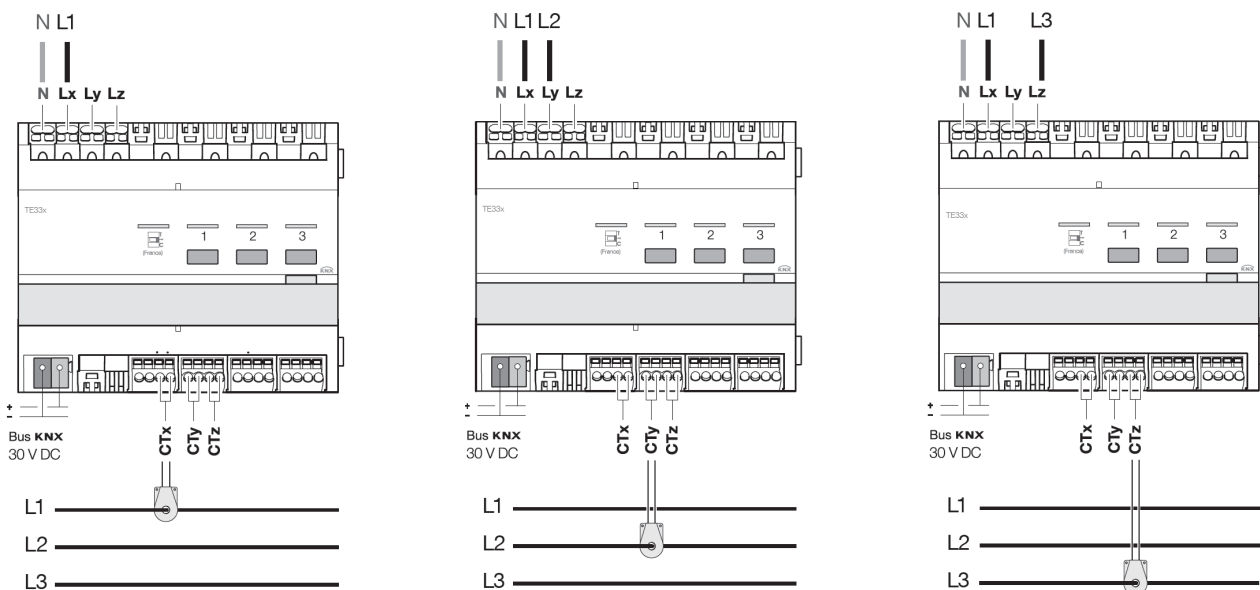

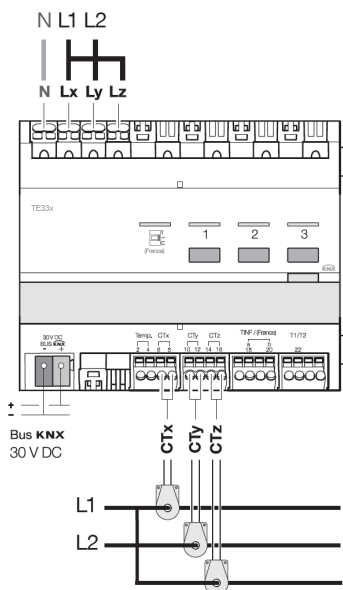
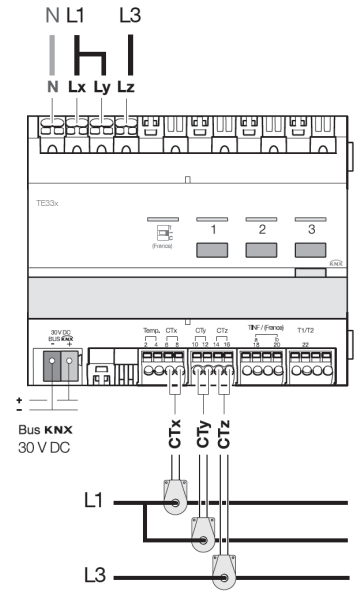
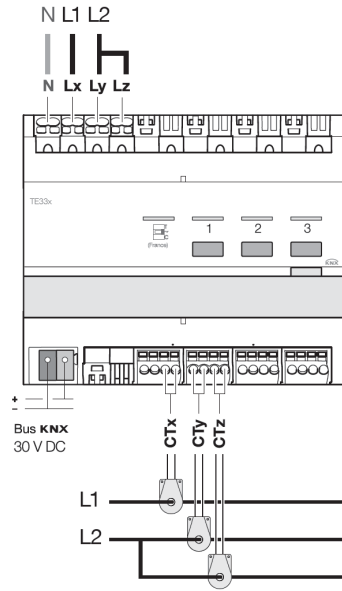
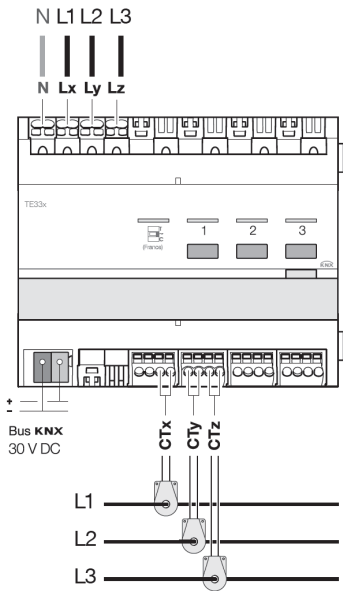
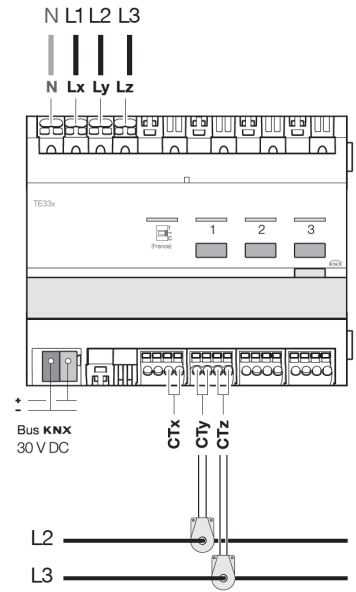
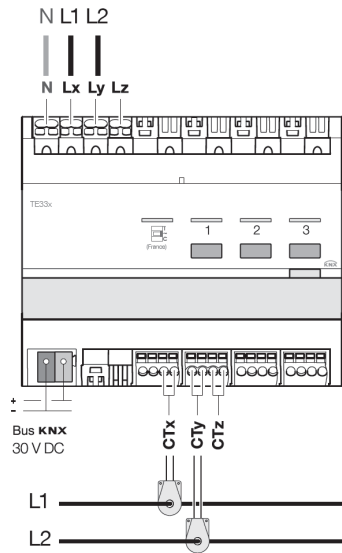
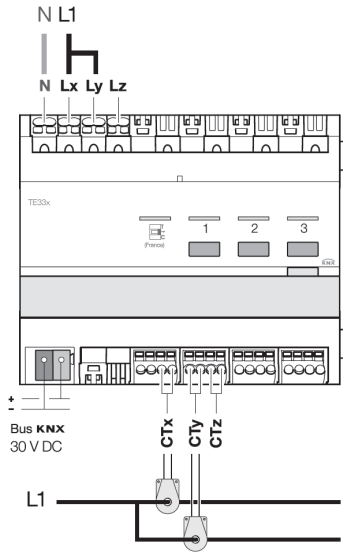

6. Main characteristics

Max. number of group addresses	254
Max. number of links	255
Objects	107

7. Physical addressing

To perform physical addressing or check for the presence of the bus, press the illuminated pushbutton located on the top right of the device above the label holder.

Programming LED ON = Bus present and the product is in programming mode.

The product remains in programming mode until the physical address has been transmitted by ETS. Press again to exit programming mode.

